

# GEOHERMAL & COMMERCIAL WSHP ACCESSORIES



**This catalog contains the following geothermal accessory products and specification guides:**

<b>PRODUCT</b>	<b>PAGE</b>
Commercial Water Source Heat Pump	
Hanging Display.....	2
Deluxe Flow Center .....	3
Standard Flow Center .....	5
Double O-Ring Flow Center .....	7
O-Ring Fittings .....	8
Pressurized Loop Pump .....	9
Geothermal Accessory Fittings.....	10
Geothermal/WSHP Tools, Controls, and Hose Kits .....	11-17

Geothermal systems offer an effective way to cut utility costs while ensuring comfort. **MARS** line includes two stage and single stage geothermal heat pumps, both package and split system types. Additionally, we offer a full range of accessories required to configure and install these systems.

**CHOOSE RELIABILITY  
AND EFFICIENCY.**

# HANGING DISPLAYS

## Commercial WSHP Hanging Display



*Lifesize ultra-realistic lightweight foam-board model*

### Part #HBHD

**34" L x 19" W x 11" T**

*(Display includes 24 x 15 foam sign with velcro & ceiling hanger hardware)*



*Comfort-Circ*

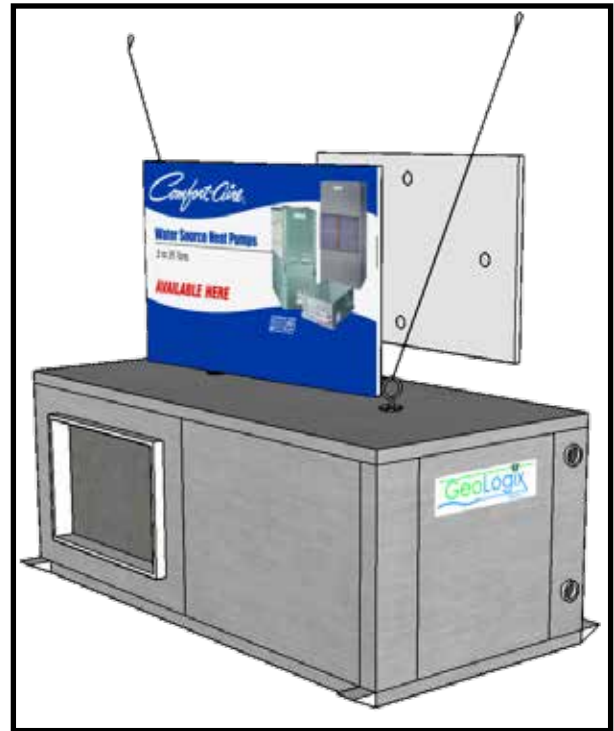

## Commercial WSHP Hanging Display



*Lifesize ultra-realistic lightweight foam-board model*

### Part #HBHD-CY

**34" L x 19" W x 11" T**

*(Display includes 24 x 15 foam sign with velcro & ceiling hanger hardware)*



*Century*

# DELUXE FLOW CENTER



## Reliable operation, stylish appearance

The Deluxe Flow Center is a non-pressurized pumping station that's housed in an attractive, durable cabinet, and is a recommended accessory for the installation of closed loop geothermal systems.

The Deluxe Flow Center includes patented features not available in any other system including its built-in pump protection. This design eliminates the need for a flush cart when filling and flushing a closed loop system with indoor manifolds. Because it is non-pressurized, the flow center allows you to add fluids like antifreeze or water, while automatically eliminating air from the closed loop system.

## Simple to install

The Deluxe Flow Center is completely assembled at the factory to simplify installation, which is completed by connecting a return line from the loop system to the Deluxe Flow Center and then connecting a supply line from the Deluxe Flow Center to the heat pump unit.

## Easy to operate and maintain

The QT Flow Center system includes self-sealing features that keep air out and water in. For you, that means trouble-free operation, easier installation and fewer call backs. For the homeowner, it means added reliability.

Adding antifreeze is easy. Just remove the self-sealing top and pour the liquid into the air elimination chamber. The top is completely sealed to keep dirt and air out—an exclusive feature of the Deluxe Flow Center.

The only moving parts of the system are the pumps, helping make service minimal. Each part can be removed for servicing without risk of fluid loss or air entry into the system.

## Smart addition to water source technology

A geothermal system is a significant investment for the homeowner and one he will want to protect. Recommending the Deluxe Flow Center will not only add to the dependability of the closed loop system, it will add to the customer's satisfaction in the long run.

CATALOG NO.	ITEM
7602-402	1-Pump 230V Flow Center
7602-403	2-Pump 230V Flow Center
7602-407	Flow Meter Tool (pg. 10)
7602-408	Wrench

## Features & Benefits

**Removable Lid**—Makes it easy to install, fill the unit, check flow rates and add antifreeze.

**Air Separation Chamber**—Continually performs purging function.

**Foam Insulation**—Eliminates unsightly condensation, assures quiet operation.

**Solid, Durable Construction**—Designed for long life while maintaining an attractive appearance.

**Check Valve**—Protects the pump(s) by keeping water on the bearing even if the chamber runs dry.

**Built-in Handles**—Makes it easy to handle the unit during installation.

# DELUXE FLOW CENTERS

Deluxe Flow Center	Pumps	Power	Insulation	Approx. Volume of Fluid	Water Pump	Dimensions			Weight (lbs.)
						H	L	W	
7602-402	1	230/1/60	Foam Cabinet	4.5 Gal.	Grundfos 26-99	35"	15"	7 3/4"	40
7602-403	2	230/1/60	Foam Cabinet	4.5 Gal.	Grundfos 26-99	35"	15"	7 3/4"	55

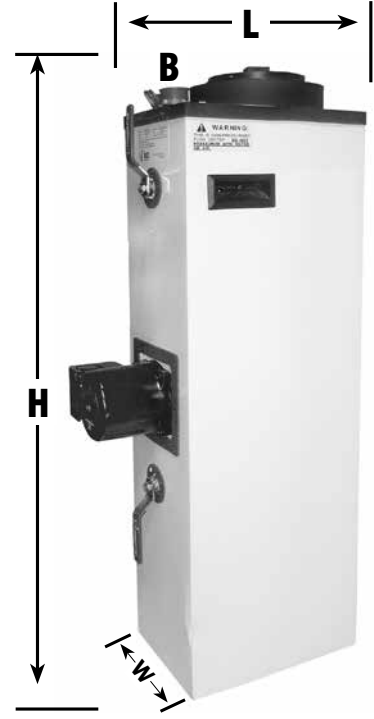
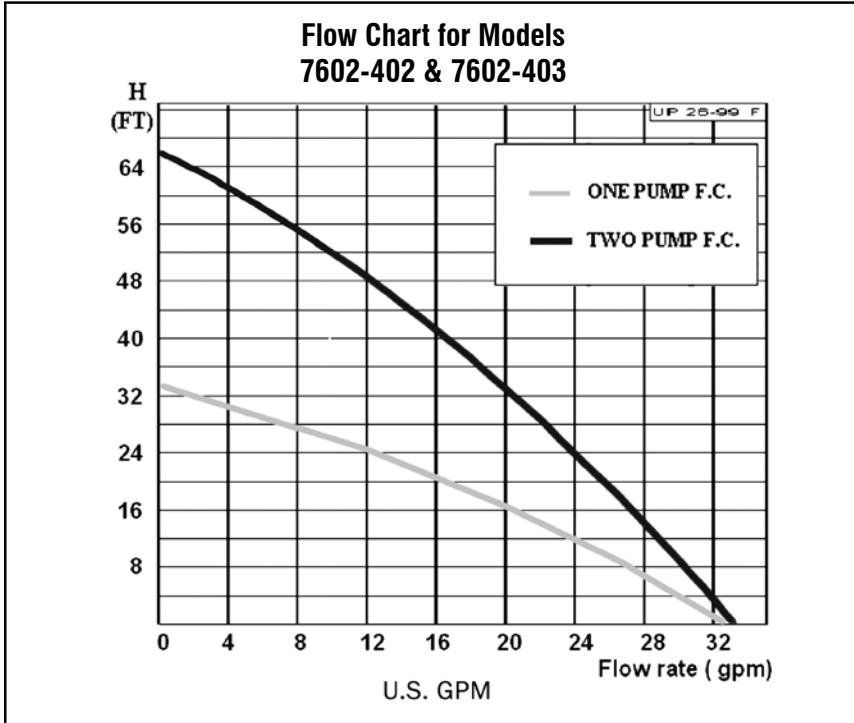

**Model 7602-402**

B = 1" FNPT with ball valve

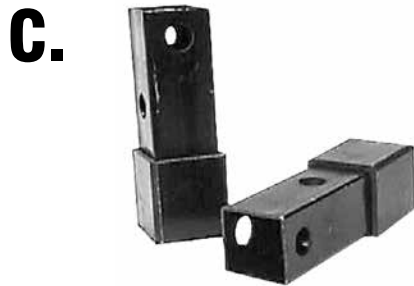

- A. View from side of flow center
- B. View from top of flow center
- C. Wrench for flow center top [separate accessory]

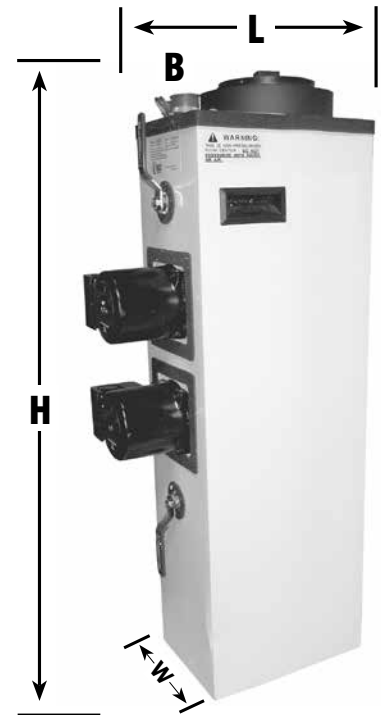

**Model 7602-403**

B = 1" FNPT with ball valve

# STANDARD FLOW CENTER

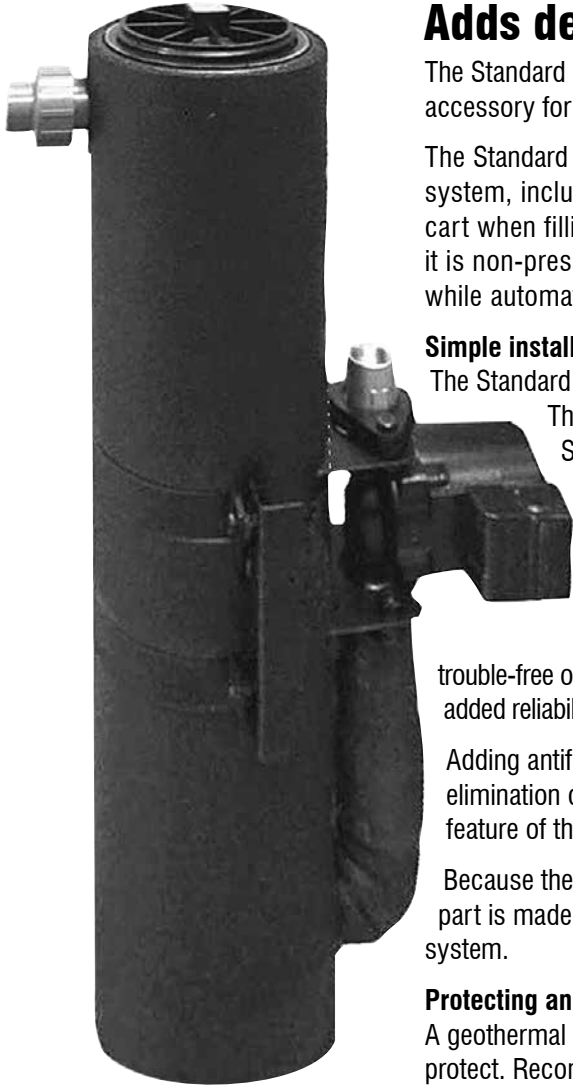

## Adds dependability to a closed loop system

The Standard Flow Center is a non-pressurized pumping station that's a recommended accessory for the installation of closed loop geothermal systems.

The Standard Flow Center incorporates patented features not available in any other system, including built-in pump protection. This design eliminates the need for a flush cart when filling and flushing a closed loop system with indoor manifolds. Because it is non-pressurized, the flow center allows you to add fluids like antifreeze or water, while automatically eliminating air from the closed loop system.

### Simple installation

The Standard Flow Center is completely assembled at the factory to simplify installation. The unit is installed by connecting a return line from the loop system to the Standard Flow Center. Then connect a supply line from the Standard Flow Center to the heat pump unit. That's all there is to adding reliable pump protection to any closed loop system.

### Easy to operate and maintain

The Standard Flow Center system is designed for dependability. The system includes self-sealing features that keep air out and water in. For you, that means trouble-free operation, easier installation and fewer call backs. For the homeowner, it means added reliability.

Adding antifreeze is easy. Just remove the self-sealing top and pour the liquid into the air elimination chamber. The top is completely sealed to keep dirt and air out—an exclusive feature of the Standard Flow Center.

Because the only moving parts of the system are the pumps, service is minimal. Each part is made to be removed for servicing without risk of fluid loss or air entry into the system.

### Protecting an investment

A geothermal system is a significant investment for the homeowner and one he will want to protect. Recommending the Standard Flow Center will not only add to the dependability of the closed loop system, it will add to the customer's satisfaction in the long run.

CATALOG NO.	ITEM
7602-404	1-Pump 230V Flow Center
7602-405	2-Pump 230V Flow Center
7602-407	Flow Meter Tool (pg. 10)
7602-408	Wrench

## Features & Benefits

**Removable Lid**—Makes it easy to install, fill the unit, check flow rates and add antifreeze.

**Air Separation Chamber**—Continually performs purging function.

**Foam Insulation**—Eliminates unsightly condensation, assures quiet operation.

**Solid, Durable Construction**—Designed for long life while maintaining a low profile appearance.

**Check Valve**—Protects the pump(s) by keeping water on the bearing even if the chamber runs dry.

**Dip Tube**—Improves system performance by preventing air entry into the closed loop system.



# STANDARD FLOW CENTERS

Standard Flow Center	Pumps	Power	Insulation	Approx. Volume of Fluid	Water Pump	Dimensions			Weight (lbs.)
						H	L	D	
7602-404	1	230/1/60	3/8" Foam	4.5 Gal.	Grundfos 26-99	35"	15 1/2"	6"	35
7602-405	2	230/1/60	3/8" Foam	4.5 Gal.	Grundfos 26-99	35"	15 1/2"	6"	47

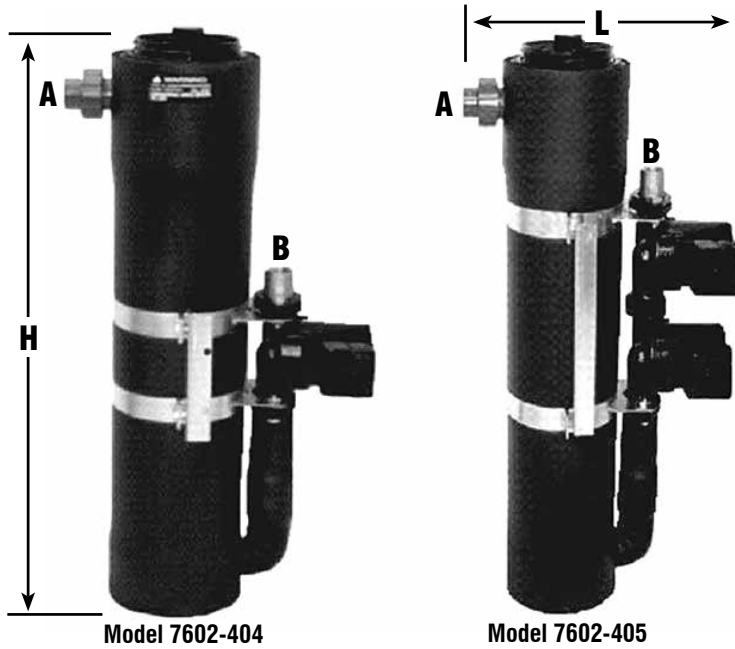

## Specifications

A = 1" Union PVC

B = 1" FNPT with ball valve

Material: 6" SDR35 D3034 PVC

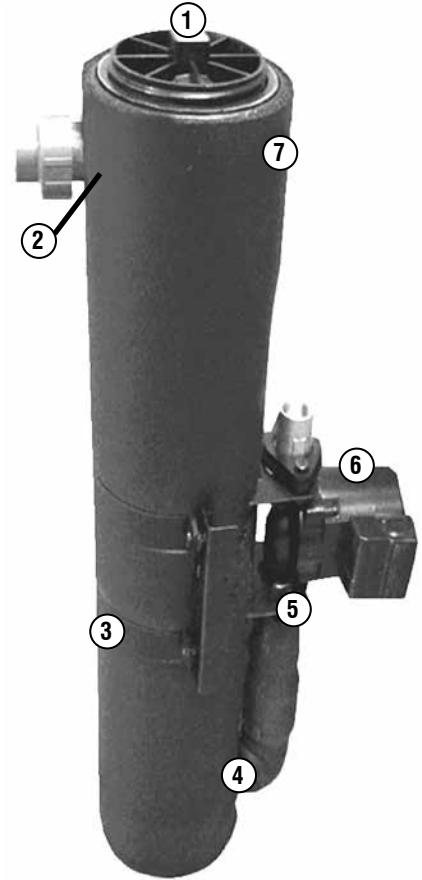

## Detailed part description

- 1. SELF-SEALING TOP**—All fluids are poured in the top of the chamber for filling, flushing and adding anti-freeze.
- 2. DIP TUBE**—Improves system performance by preventing air entry into the closed loop system. (internal, not shown)
- 3. TANK**—Includes a self-sealing, removable screw-on top for ease in installation.
- 4. BUILT-IN CHECK VALVE**—Holds water in the pump volutes after initial filling. This protects the pump by keeping water on the bearing even if the chamber runs dry.
- 5. BALL VALVE**—Allows each pump to be removed for service without the risk of fluid loss to the system
- 6. PUMP(S)**—Circulate fluid throughout the earth loop system (7602-404 has one pump while the 7602-405 has two pumps).
- 7. AIR ELIMINATION CHAMBER**—Removes air from the system as it is circulated through the canister.

Flow Chart for Models 7602-404 & 7602-405

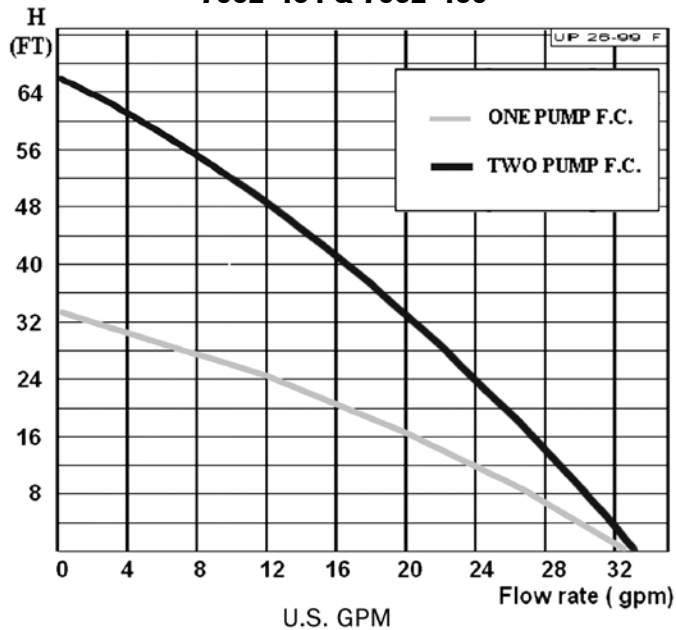

# DOUBLE O-RING LOOP PUMP

## O-Ring design eliminates leaks

Our Double O-Ring Loop Pump, built with a high impact polystyrene cabinet, contains 3-way valves and pumps with connections for flushing, filling and pumping residential geothermal closed loop systems. The double O-ring design allows the connections to be hand tightened for ease of installation.

This enhanced, proven design is foam insulated to prevent condensation and will not rust. Full flow service valves minimize pressure drop. The Double O-Ring Loop Pump also utilizes the industry standard Grundfos circulator pumps.

### Installation

The module comes fully assembled and leak tested; external connections are double O-ring. The light weight module can be easily mounted to the wall using the slotted mounting holes in the built-in mounting brackets.

### Operation

The heat pump and earth loop are filled and flushed through the side connections; the composite valves rotate to four different positions to direct the flow of liquid solution, also allowing isolation of the heat pump or loop as needed for maintenance.



Composite Valve Flow Center—Single



Composite Valve Flow Center—Dual

## PRESSURIZED LOOP PUMP SPECIFICATIONS

- **Power Supply:** 230V-1Ph-60Hz
- **Volume:** **Single Pump:** 20 GPM Maximum @ 15 ft head  
**Dual Pump:** 20 GPM Maximum @ 30 ft head
- **Maximum Operating Pressure:** 150 PSI
- **Maximum Operating Temperature:** 120°F
- **Minimum Operating Temperature:** 20°F
- **Connection Size:** 1" Double O-Ring
- **Approx. Weight in lbs.:** 26 single pump/32 dual pump

Double O-Ring Module Pump Curves

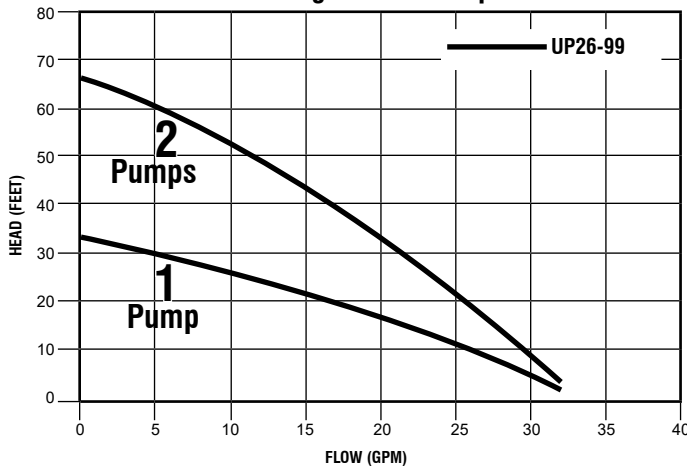

CATALOG NO.	ITEM
7602-423	Single Pump Flow Center
7602-424	Dual Pump Flow Center

(Order Double O-Ring fittings from page 6)

# DOUBLE O-RING LOOP PUMP FITTINGS

For use with installations utilizing Double O-Ring Loop Pumps



**1 1/4" Socket Fusion  
7602-425**



**Garden Hose Male  
7602-429**



**1" Cam Lever Male  
7602-426**



**Elbow, 1" MPT  
7602-430**



**1" MPT  
7602-427**



**1" Hose Barb  
7602-431**



**1" Copper Sweat  
7602-428**



**Elbow, 1" Hose Barb  
7602-432**



# STANDARD PRESSURIZED LOOP PUMP

## Circulates fluid through a closed loop

Our Standard Pressurized Loop Pump modules, used for closed loop geothermal installations, are designed to circulate the liquid solution through the heat exchanger of the geothermal heat pump, out through the loop and back, so heat transfer can occur.

The pump module is compact at just 14 1/8" tall and engineered for quiet, reliable operation. The heavy duty cabinet is insulated with thick foam to eliminate condensation and includes full flow 1" brass valves.

### Installation

The module comes fully assembled and leak tested; external connections are 1" FPT. The module can be easily mounted to the wall using the slotted mounting holes in the built-in mounting brackets. Connection of the module to the heat pump is quick and easy with the hose kit listed below.

### Operation

The heat pump and earth loop are filled and flushed through the side connections; the two brass valves rotate to four different positions to direct the flow of liquid solution, also allowing isolation of the heat pump or loop as needed for maintenance.



**Brass Valve Flow Center—Single**



**Brass Valve Flow Center—Dual**

## PRESSURIZED LOOP PUMP SPECIFICATIONS

- **Power Supply:** 230V-1Ph-60Hz
- **Volume:** **Single Pump:** 20 GPM Maximum @ 15 ft head  
**Dual Pump:** 20 GPM Maximum @ 30 ft head
- **Maximum Operating Pressure:** 150 PSI
- **Maximum Operating Temperature:** 120°F
- **Minimum Operating Temperature:** 20°F
- **Connection Size:** 1" FPT
- **Approx. Weight in lbs.:** 38 single pump/42 dual pump

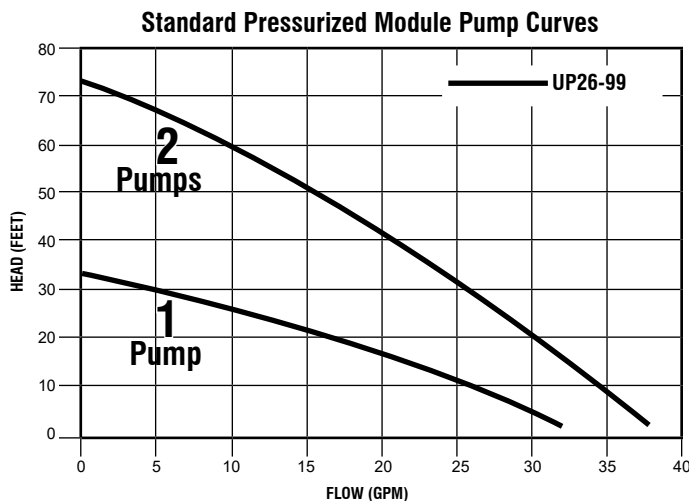

CATALOG NO.	ITEM
7602-300	Single Pressurized Pump
7602-301	Dual Pressurized Pump
7602-103	1" Neoprene Hose Kit*

\*Hose kit includes one 12' neoprene hose, two MPT 1" barbed connectors, two 90° MPT 1" barbed connectors with PT ports, and four hose clamps.

# GEOTHERMAL ACCESSORY FITTINGS

For use with open and/or closed loop geothermal installations

## OPEN

The following accessories are used exclusively in open loop geothermal installations



### Flow Controllers

7602-203	3 GPM	3/4" MPT X FPT
7602-204	4 GPM	3/4" MPT X FPT
7602-205	5 GPM	3/4" MPT X FPT
7602-206	6 GPM	3/4" MPT X FPT
7602-207	7 GPM	3/4" MPT X FPT
7602-208	8 GPM	3/4" MPT X FPT
7602-209	9 GPM	3/4" MPT X FPT
7602-210	10 GPM	1" MPT X FPT
7602-211	11 GPM	1" MPT X FPT
7602-212	12 GPM	1" MPT X FPT
7602-213	13 GPM	1" MPT X FPT



### Motorized Geo Zone Valves

7602-150	3/4" FPT
7602-151	1" SWT



### Modulating Geo Zone Valves

Recommended for use with 7602-457  
Thermostat and DXM2 Control Board

7602-441	3/4" FPT (2-4 Ton)
7602-442	1" FPT (5 Ton)

## CLOSED

The following accessories are used exclusively in closed loop geothermal installations



1 1/4" Couplings x 1" Fusion Flange with nut  
7602-409



Fusion x MPT Adaptor  
1" x 1" MPT - 7602-410  
1 1/4" x 1" MPT - 7602-411



1 1/4" PVC Transition Socket x Brass FPT  
7602-420



Geo-Gooser  
Used to boost pressure in loops  
7602-419



PE to PVC with union  
1" PE to 1" PVC with union - 7602-412  
1 1/4" PE to 1 1/4" PVC  
with union - 7602-413

(For Neoprene Hose Kits,  
see page 11)

## BOTH

The following accessories can be used for in both open and closed loop geothermal installations



Hot Water Concentric Connector  
2040-0114



Gauge Adapter PT Plug with guard  
7602-416



Heat Pump Adapter 1" MPT x 1" HB  
7602-418



Insert Adapter 1" MPT x 1" HB  
7602-417



PT Plug  
1/4" MPT - 7602-414  
1/2" MPT - 7602-415

# GEOHERMAL/WSHP TOOLS, CONTROLS, AND HOSE KITS

## FLOW METER

### For clear, dependable readings

A flowmeter tool is used specifically with geothermal and water source heat pump system applications that use non-pressurized flow centers. A flow meter is a removable tool that can be carried from job site to job site to check systems for proper flow rates.

Each flowmeter is machined of high quality, acrylic rod stock and carefully polished for a ultra-clear finish to provide the most accurate and repeatable reading. Flowmeters feature easy to read scales screen printed on the meter body.

CATALOG NO.	ITEM
7602-407	Flow Meter Tool

Used in models 7602-402, 7602-403, 7602-404, 7602-405 only

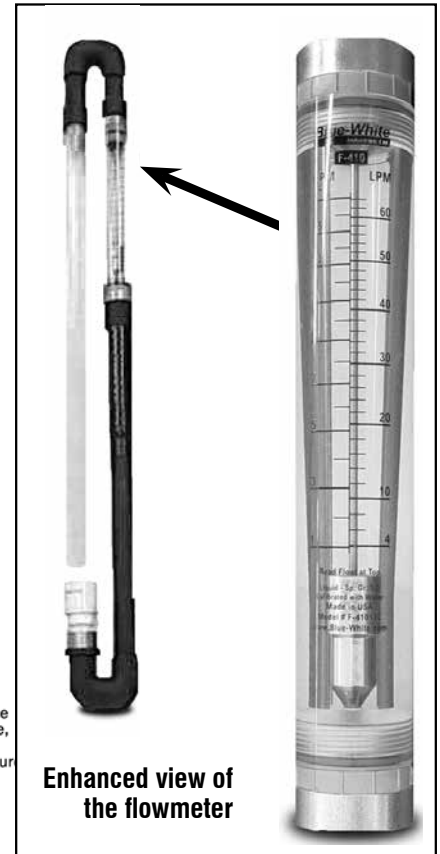
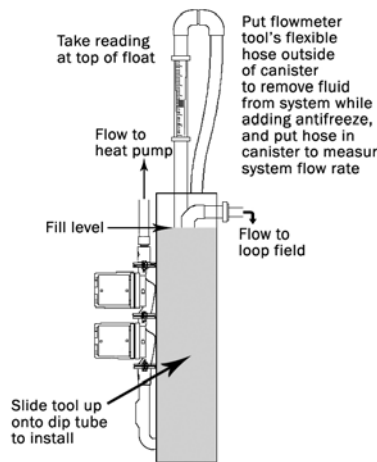

## FUSION KIT

### Safe, dependable kit for fusing tubes in geothermal systems

The R63 TE socket fusion tool is designed specifically for use in fusing tubing used in geothermal and water source systems. The fusion kit is practical, easy to handle and safe, thanks to the warning lights (main power ON and working temperature OK), the plastic ergonomic handle and excellent thermal insulation provided by the stainless steel wiring enclosure.

The tool is supplied with an electronic thermal regulator with temperature set at 500°F (260°C) on the socket and possibility to adjust from 82°F (180°C) to 560°F (290°C) on the plate with the adjustable temperature. Two year limited warranty.



CATALOG NO.	ITEM
7602-406	Fusion Kit Socket Set
7602-421	Socket Fusion 1" add on kit

### Included in the tool kit

3/4" & 1-1/4" set

R63 TE Socket Fusion Tool	Socket Face Set - 3/4" and 1 1/4" IPS	Fusion Tool Mounting Bracket
Depth Gauge - 3/4" and 1 1/4"	Cold Rings - 3/4" and 1 1/4"	Tempstik 500° & 525°F (one of each)
Hex Key	Roll Cutter 3/4" - 2"	Second Timer
Tool Cover Bag	Kwik Cutter (up to 2" IPS)	Cotton Wipe Rag

# GEOTHERMAL/WSHP TOOLS, CONTROLS, AND HOSE KITS

## FLUSH CART

### Easy to cart from jobsite to jobsite

Heavy duty stainless steel flush carts, available in either 1.5 or 2 HP pumps, provide the proper amount of head required to fill, flush and purge loops. Each flush system is factory mounted to a heavy duty cart for great maneuverability and easy transportation to and from the job site. The cart's design also features supports on the back for hoses to be mounted.

CATALOG NO.	ITEM
7602-400	Flush Cart 1.5 HP 115V
7602-401	Flush Cart 2 HP 115V

### Features

**VALVES**– Equipped with 1/4" full port valves with 1" (1 1/2 HP) and 1/4" hose (2 HP)

**DRAIN**– Antifreeze flush drain

**MOTOR**– Flush carts are available with 1 1/2 and 2 horse power motors (115V)

**PUMP**– 60 GPM at 68 FT head on the 1 1/2 HP motor and 90 GPM at 62 FT head on the 2 HP motor

**CART**– Flush systems are factory mounted to a heavy duty cart with 13" wheels and includes mounts on the back for hoses. Flush carts include a pressure drain, 14-gauge stainless steel tanks (10 gallons), stainless steel piping, a gravity drain, quick connect couplings, lift out filter screen and water tight switch box located on the back of the cart.



### Specifications

Flush Cart	7602-400	7602-401
Cart Material	Mild Steel	Mild Steel
Tank Material	304L Stainless Steel	304L Stainless Steel
Piping	304 Stainless, Red Brass	304 Stainless, Red Brass
Piping Size	1 1/4"	1 1/4"
Valves	Yellow Brass	Yellow Brass
Valve Size	1 1/4"	1 1/4"
Drain Valves	Stainless (Hose Bib)	Stainless (Hose Bib)
Hoses	150 PSI Rubber Hose	200 PSI Rubber Hose
Hose Size	1"	1 1/4"
Pump	60 GPM @ 68FT Head	90 GPM @ 62 FT Heat
Electrical Plug	20 Amp ~ 115V	20 Amp ~ 115V
Hose Connections	1" Cam and Groove	1 1/4" Cam and Groove
Total Weight	160 lbs. w/out hoses, 174 lbs. w/hoses	163 lbs. w/out hoses, 178 lbs. w/hoses
Dimensions	H=57" W=22 1/4" D=25"	H=57" W=22 1/4" D=25"
Tank Volume	10 Gallons	10 Gallons
Filter	In Tank; Double Woven Screen	In Tank; Double Woven Screen

# GEOHERMAL/WSHP TOOLS, CONTROLS, AND HOSE KITS

## 7602-444

### Diagnostic Tool (for use with DXM2 Control Board systems only)

The 7602-444 diagnostic tool is a must-have for any installer and technician who works with Comfort-Aire or Century Geothermal / Commercial Water-Source-Heat-Pumps on a regular basis. Designed to quickly plug in at the unit, the 7602-444 diagnostic tool allows the installer or technician to actively control operation within arms' length of the system. Additionally, the tool will allow configuration of airflow, options, programming of the DXM2 control board, as well as to assist in diagnosing performance issues, viewing dip-switch configuration and fault history, and even operating conditions when the fault occurred. Comes complete with sturdy, plastic carrying case and quick-connect wiring harness.



CATALOG NO.	ITEM
7602-444	Diagnostic Tool

## 7602-457

### Thermostat (for use with DXM2 Control Board systems only)

The 7602-457 communicating programmable thermostat is the perfect compliment to your new Comfort-Aire or Century Geothermal / Commercial Water-Source-Heat-Pump. For homeowners, the thermostat provides customizable climate control features designed to maximize comfort and reduce energy consumption. For installers and technicians, the 7602-457 is an easy-to-install 4-wire connection system control that offers real-time performance measurements, diagnostics, fault information, and DXM2 board programming/setup. For use with all systems utilizing DXM2 Control Boards.

CATALOG NO.	ITEM
7602-457	Thermostat





# GEOHERMAL/WSHP TOOLS, CONTROLS, AND HOSE KITS

## Hose Kit Diagram

### AUTOMATIC FLOW CONTROL AND SS HOSES KITS

1/2"	760X-135015	760X-135020	760X-135050
3/4"	760X-131060	760X-131080	760X-131100
1"	760X-132120	760X-132150	

1-1/4"	760X-133180	760X-133200	760X-133300		
1-1/2"	760X-134200	760X-134300	760X-134400	760X-134500	760X-134600

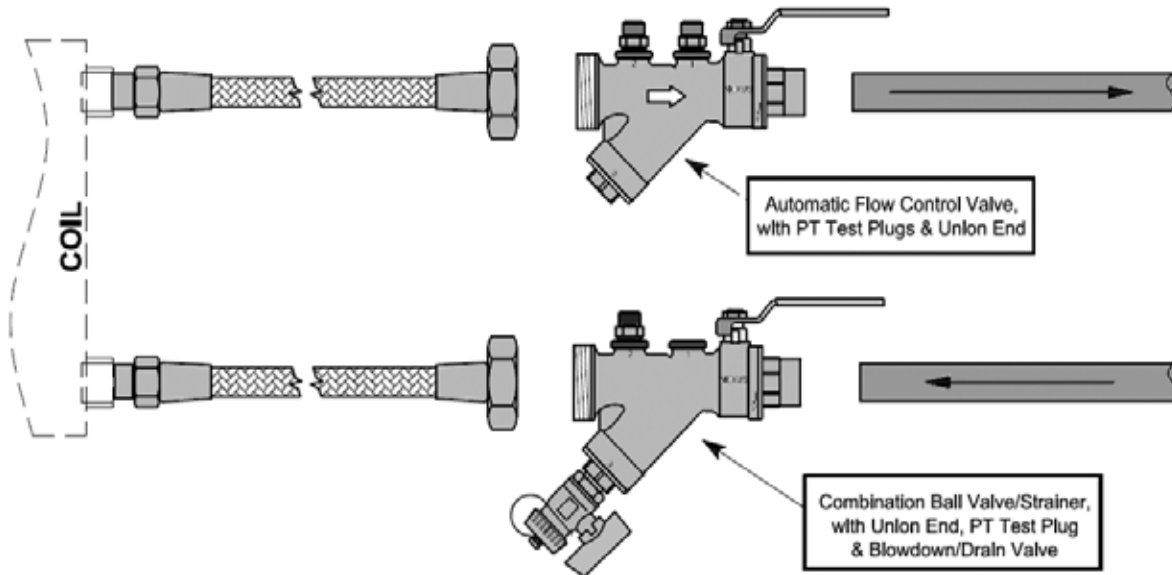

### MANUAL BALANCE VALVE AND SS HOSES KITS

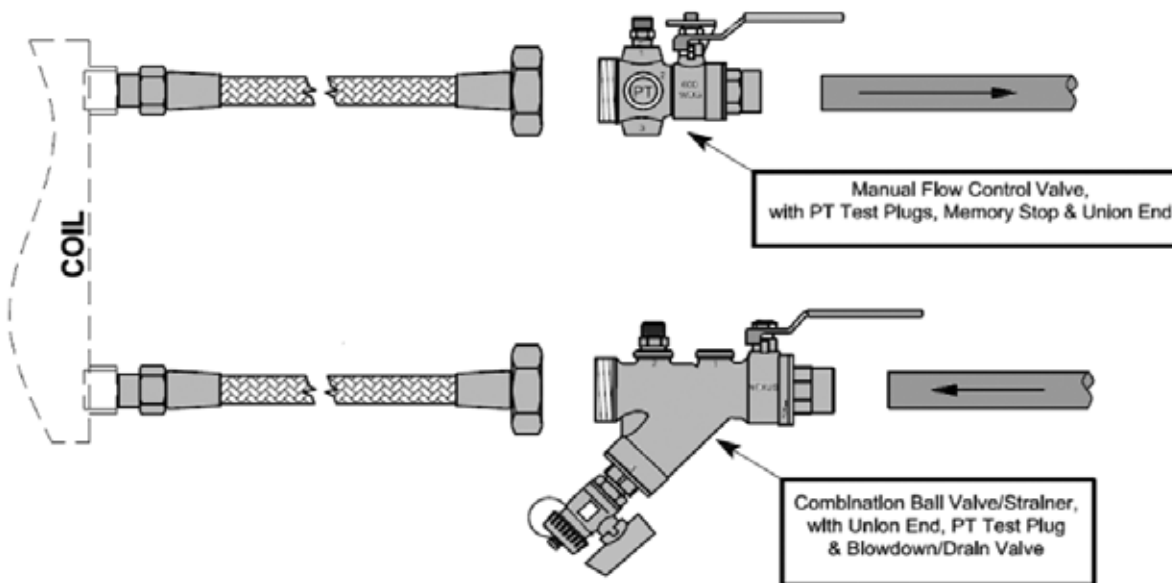

1/2"	760X-130
1"	760X-132
1-1/2"	760X-134
3/4"	760X-131
1-1/4"	760X-133

# GEOHERMAL/WSHP TOOLS, CONTROLS, AND HOSE KITS

For latest AHRI ratings, please visit [www.marsdeliversratings.com](http://www.marsdeliversratings.com) or [AHRIdirectory.org](http://AHRIdirectory.org)

## COMMERCIAL WATER SOURCE HEAT PUMP ACCESSORIES

### 2' HOSES AND HOSE KITS – Hoses with Automatic Flow Controls and Shut-Off Valves

Hose Kits	Connection Size (in)	Connection Type		Hose Length/Overall Length (ft.)	Hose Material	Shut-Off Valve w/ Auto Flow Control	GPM	Shut Off Valve & Strainer	P/T Port	Drain Valve
		Unit	Field							
7602-135015	1/2	MPT	FPT	2/3	SS	Return	1.5	Supply	Supply/Return	Supply
7602-135020	1/2	MPT	FPT	2/3	SS	Return	2.0	Supply	Supply/Return	Supply
7602-135030	1/2	MPT	FPT	2/3	SS	Return	3.0	Supply	Supply/Return	Supply
7602-135050	1/2	MPT	FPT	2/3	SS	Return	5.0	Supply	Supply/Return	Supply
7602-131060	3/4	MPT	FPT	2/3	SS	Return	6.0	Supply	Supply/Return	Supply
7602-131080	3/4	MPT	FPT	2/3	SS	Return	8.0	Supply	Supply/Return	Supply
7602-131090	3/4	MPT	FPT	2/3	SS	Return	9.0	Supply	Supply/Return	Supply
7602-131100	3/4	MPT	FPT	2/3	SS	Return	10	Supply	Supply/Return	Supply
7602-132120	1	MPT	FPT	2/3	SS	Return	12	Supply	Supply/Return	Supply
7602-132150	1	MPT	FPT	2/3	SS	Return	15	Supply	Supply/Return	Supply
7602-132180	1	MPT	FPT	2/3	SS	Return	18	Supply	Supply/Return	Supply
7602-133180	1 1/4	MPT	FPT	2/3	SS	Return	18	Supply	Supply/Return	Supply
7602-133200	1 1/4	MPT	FPT	2/3	SS	Return	20	Supply	Supply/Return	Supply
7602-133300	1 1/4	MPT	FPT	2/3	SS	Return	30	Supply	Supply/Return	Supply
7602-134200	1 1/2	MPT	FPT	2/3	SS	Return	20	Supply	Supply/Return	Supply
7602-134300	1 1/2	MPT	FPT	2/3	SS	Return	30	Supply	Supply/Return	Supply
7602-134400	1 1/2	MPT	FPT	2/3	SS	Return	40	Supply	Supply/Return	Supply
7602-134500	1 1/2	MPT	FPT	2/3	SS	Return	50	Supply	Supply/Return	Supply
7602-134600	1 1/2	MPT	FPT	2/3	SS	Return	60	Supply	Supply/Return	Supply

### HOSES ONLY (2 Required)

Hose Part Number	Connection Size (in)	Connection Type		Hose Length (ft)	Hose Material	P/T Port
		Unit	Field			
7602-101	3/4	MPT	MPT	3	SS	No
7602-100	1	MPT	MPT	3	SS	No

### NEOPRENE HOSE KITS

Hose Kit	Connection Size (in)	Connection Type		Hose Length (ft)	Hose Material	P/T Port
		Unit	Field			
7602-102	3/4	MPT	MPT	12 (cut to length)	Neoprene	Supply/Return
7602-103	1	MPT	MPT	12 (cut to length)	Neoprene	Supply/Return

NOTE: Kits contain 1/2" Neoprene hose, 2'-90" mpt x barbed connectors w/P/T Ports, 2-mpt x barbed connectors, 4 screw hose clamps.

### HOSES WITH BALANCE AND SHUT OFF VALVES

Hose w/Shut Off Valve	Connection Size (in)	Connection Type		Hose Length/Overall Length (ft.)	Hose Material	Balance Shut Off Valve w/memory	Shut Off Valve & Strainer	P/T Port	Drain Valve
		Unit	Field						
7602-130	1/2	MPT	FPT	2/3	SS	Return	Supply	Supply/Return	Supply
7602-131	3/4	MPT	FPT	2/3	SS	Return	Supply	Supply/Return	Supply
7602-132	1	MPT	FPT	2/3	SS	Return	Supply	Supply/Return	Supply
7602-133	1 1/4	MPT	FPT	2/3	SS	Return	Supply	Supply/Return	Supply
7602-134	1 1/2	MPT	FPT	2/3	SS	Return	Supply	Supply/Return	Supply

# GEOHERMAL/WSHP TOOLS, CONTROLS, AND HOSE KITS

For latest AHRI ratings, please visit [www.marsdeliveratings.com](http://www.marsdeliveratings.com) or [AHRIdirectory.org](http://AHRIdirectory.org)

## COMMERCIAL WATER SOURCE HEAT PUMP ACCESSORIES

### 3' Hoses with Automatic Flow Controls and Shut-Off Valves

Hose Kits	Connection Size (in)	Connection Type		Hose Length/Overall Length (ft.)	Hose Material	Shut-Off Valve w/ Auto Flow Control	GPM	Shut Off Valve & Strainer	P/T Port	Drain Valve
		Unit	Field							
7603-135015	1/2	MPT	FPT	3/4	SS	Return	1.5	Supply	Supply/Return	Supply
7603-135020	1/2	MPT	FPT	3/4	SS	Return	2.0	Supply	Supply/Return	Supply
7603-135030	1/2	MPT	FPT	3/4	SS	Return	3.0	Supply	Supply/Return	Supply
7603-135050	1/2	MPT	FPT	3/4	SS	Return	5.0	Supply	Supply/Return	Supply
7603-131060	3/4	MPT	FPT	3/4	SS	Return	6.0	Supply	Supply/Return	Supply
7603-131080	3/4	MPT	FPT	3/4	SS	Return	8.0	Supply	Supply/Return	Supply
7603-131090	3/4	MPT	FPT	3/4	SS	Return	9.0	Supply	Supply/Return	Supply
7603-131100	3/4	MPT	FPT	3/4	SS	Return	10	Supply	Supply/Return	Supply
7603-132120	1	MPT	FPT	3/4	SS	Return	12	Supply	Supply/Return	Supply
7603-132150	1	MPT	FPT	3/4	SS	Return	15	Supply	Supply/Return	Supply
7603-132180	1	MPT	FPT	3/4	SS	Return	18	Supply	Supply/Return	Supply
7603-133180	1 1/4	MPT	FPT	3/4	SS	Return	18	Supply	Supply/Return	Supply
7603-133200	1 1/4	MPT	FPT	3/4	SS	Return	20	Supply	Supply/Return	Supply
7603-133300	1 1/4	MPT	FPT	3/4	SS	Return	30	Supply	Supply/Return	Supply
7603-134200	1 1/2	MPT	FPT	3/4	SS	Return	20	Supply	Supply/Return	Supply
7603-134300	1 1/2	MPT	FPT	3/4	SS	Return	30	Supply	Supply/Return	Supply
7603-134400	1 1/2	MPT	FPT	3/4	SS	Return	40	Supply	Supply/Return	Supply
7603-134500	1 1/2	MPT	FPT	3/4	SS	Return	50	Supply	Supply/Return	Supply
7603-134600	1 1/2	MPT	FPT	3/4	SS	Return	60	Supply	Supply/Return	Supply

### HOSES WITH BALANCE AND SHUT OFF VALVES

Hose w/Shut Off Valve	Connection Size (in)	Connection Type		Hose Length/Overall Length (ft.)	Hose Material	Balance Shut Off Valve w/memory	Shut Off Valve & Strainer	P/T Port	Drain Valve
		Unit	Field						
7603-130	1/2	MPT	FPT	3/4	SS	Return	Supply	Supply/Return	Supply
7603-131	3/4	MPT	FPT	3/4	SS	Return	Supply	Supply/Return	Supply
7603-132	1	MPT	FPT	3/4	SS	Return	Supply	Supply/Return	Supply
7603-133	1 1/4	MPT	FPT	3/4	SS	Return	Supply	Supply/Return	Supply
7603-134	1 1/2	MPT	FPT	3/4	SS	Return	Supply	Supply/Return	Supply

# GEOHERMAL/WSHP TOOLS, CONTROLS, AND HOSE KITS

For latest AHRI ratings, please visit [www.marsdeliversratings.com](http://www.marsdeliversratings.com) or [AHRIdirectory.org](http://AHRIdirectory.org)

COMMERCIAL WATER SOURCE HEAT PUMP ACCESSORY APPLICATION GUIDE										
Commercial Applications										
UNIT MODEL NUMBERS		UNIT WATER CONNECTION SIZE								
Stainless Steel Hose Kits: Two (2) 2' or 3' Braided Hoses with Automatic Flow Control, Shut-Off Valves and PT Plugs *										
Hose Kits	Hose Connection Size FPT	Automatic Flow Rate (GPM)	Values in table are GPM/Ton (cooling)							
7602- Prefix = 2'	7603- Prefix = 3'		3.0	2.0	4.0	2.7	2.0	3.0	2.4	2.0
135015	1/2	1.5								
135020	1/2	2.0								
135030	1/2	3.0								
135050	1/2	5.0								
131060	3/4	6.0								
131080	3/4	8.0								
131090	3/4	9.0								
131100	3/4	10								
132120	1	12								
132150	1	15								
132180	1	18								
133180	1-1/4	18								
133200	1-1/4	20								
133300	1-1/4	30								
134200	1-1/2	20								
134300	1-1/2	30								
134400	1-1/2	40								
134500	1-1/2	50								
134600	1-1/2	60								
Stainless Steel Hose Kits: Two (2) 2' or 3' Braided Hoses with Manual Balance, Shut-Off Valves w/ Memory Stop and PT Plugs										
130	1/2		X	X	X	X				
131	3/4						X	X		
132	1								X	X
133	1-1/4									X
134	1-1/2									X
Stainless Steel Hoses ONLY - 36" Length (2 Required per Heat Pump)										
7602-101	3/4				X	X	X			
7602-100	1								X	X

\* These hose kits contain stainless steel hoses for the inlet and outlet of the unit. The inlet hose has a shut off valve, strainer and P/T plug. The outlet hose has a shut off valve, P/T plug and an automatic flow controller that will provide the water flow shown in the Automatic Flow Rate column.

Nomenclature Examples:	
7602-135015	1/2" Hose Connection Automatic Flow Control Hose Kit w/ 2' SS Braided Hoses, Automatic Flow Control, Blow-Down/Drain Valve Shut Off Valves, & P/T Plugs
7603-132120	1" Hose Connection Automatic Flow Control Hose Kit w/ 3' SS Braided Hoses, Automatic Flow Control Valve, Blow-Down Drain Valve, Shut Off Valves, & P/T Plugs
7602-130	1/2" Hose Connection Manual Balance Hose Kit w/ 2' SS Braided Hoses, Manual Balance Valve, Shut Off Valves, & P/T Plugs
7602-100	1" Hose Connection 3' Stainless Steel Hoses ONLY









"This product complies with all California product labeling laws including, but not limited to, the Safe Drinking Water and Toxic Enforcement Act of 1986, more commonly known as Proposition 65."

*Due to ongoing product improvements, specifications and dimensions are subject to change and correction without notice or incurring obligations. Determining the application and suitability for use of any product is the responsibility of the installer. Additionally, the installer is responsible for verifying dimensional data on the actual product prior to beginning any installation preparations.*

*Third party incentive and rebate programs have precise requirements as to product performance and certification. All products meet applicable regulations in effect on date of manufacture; however, certifications are not necessarily granted for the life of a product. Therefore, it is the responsibility of the applicant to determine whether a specific model qualifies for these incentive/rebate programs.*